

Summer Pack



مجموع الدرجات : /..... 20

(5 درجات) /

السؤال الأول / لون الإجابة الصحيحة :

Color the correct answer:

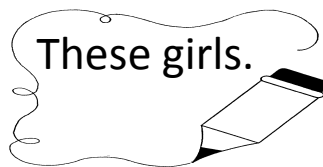
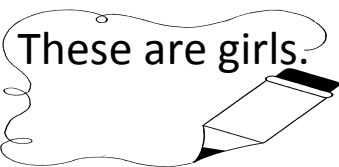
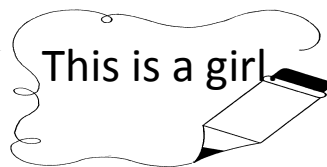
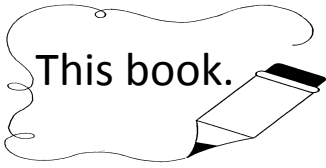

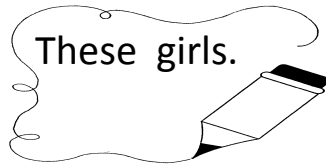
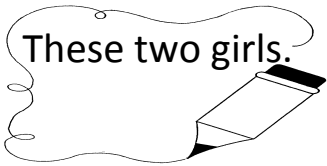
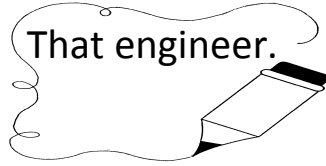

السؤال الثاني / تَرْجِمِ الْجُمْلَةَ الْآتِيَةَ إِلَى الْعَرَبِيَّةِ: (2.5 درجة)

Translate the following sentences into Arabic:

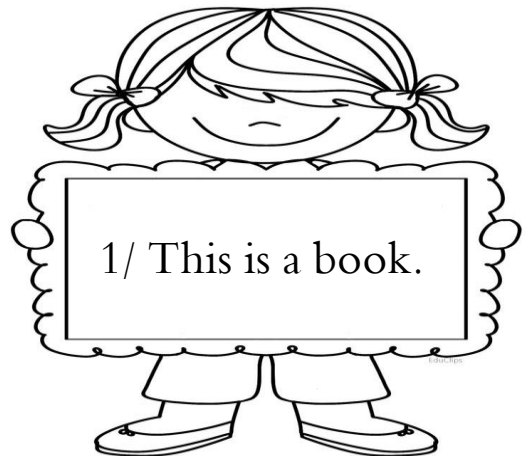
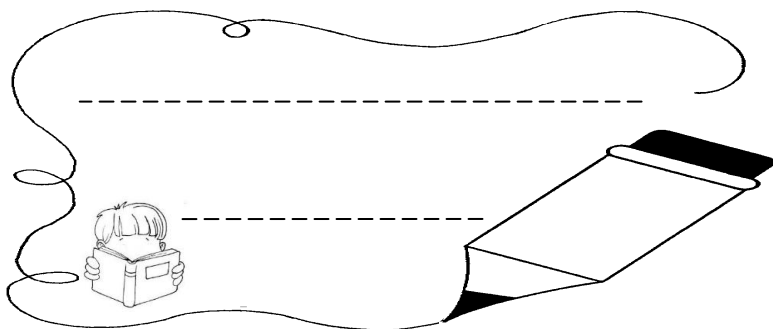

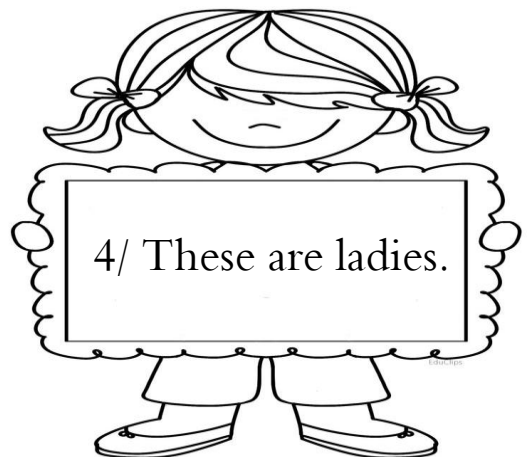
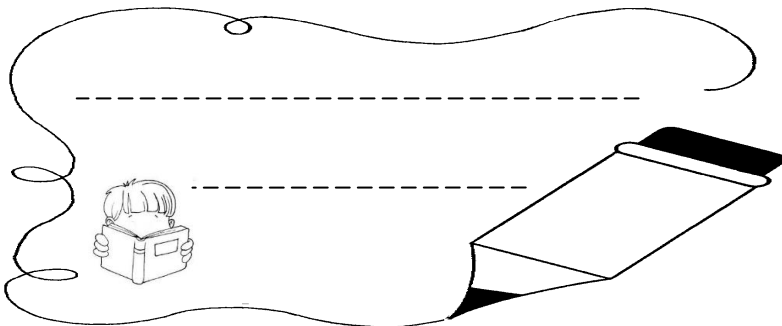
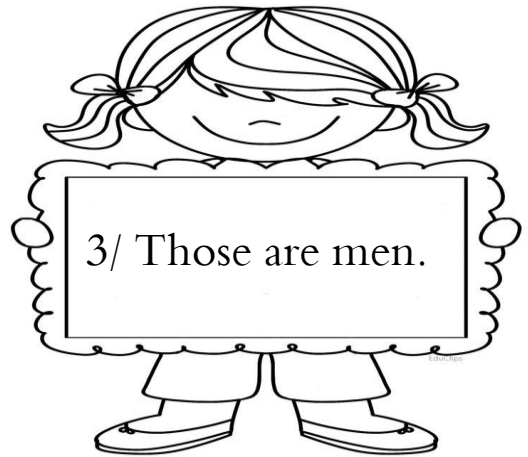
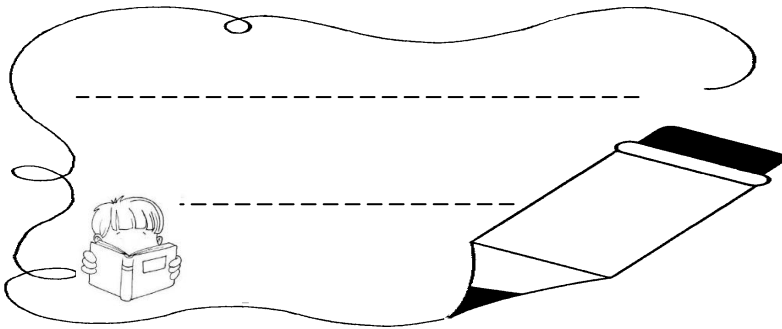
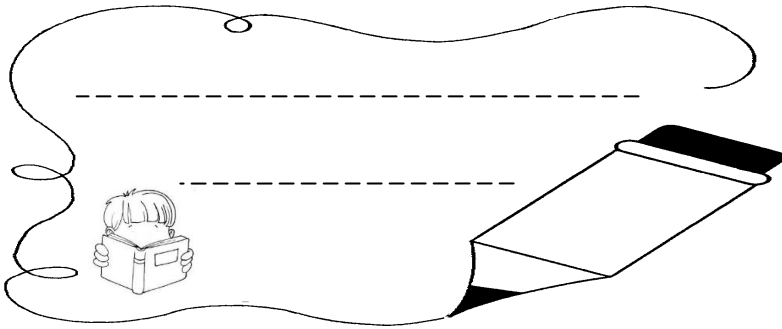

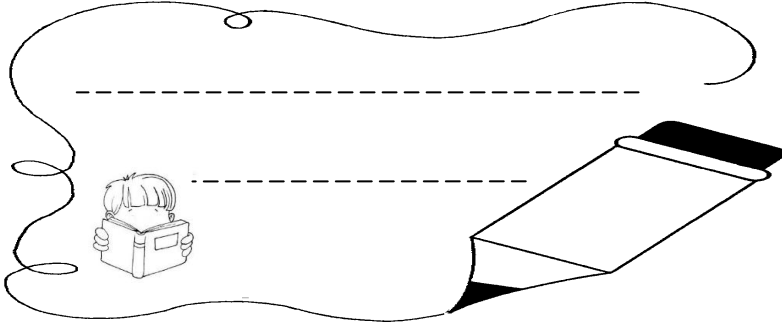

السؤال الثالث / تَرْجِمِ الْجُمْلَةَ الْآتِيَةَ إِلَى الْإِنْكَلِيزِيَّةِ: (2.5 درجة)

Translate the following sentences into English:

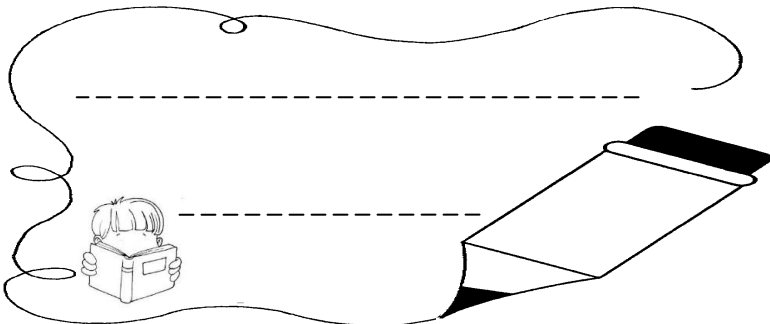
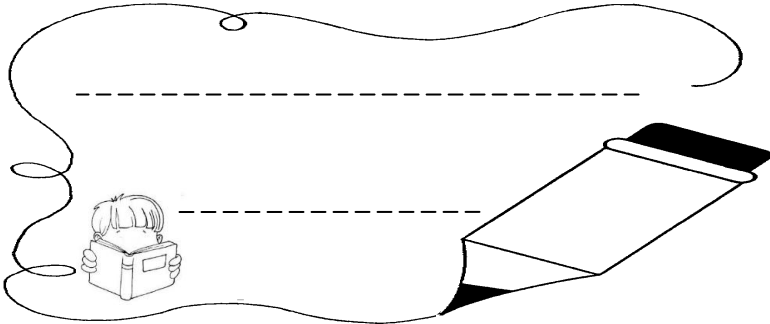

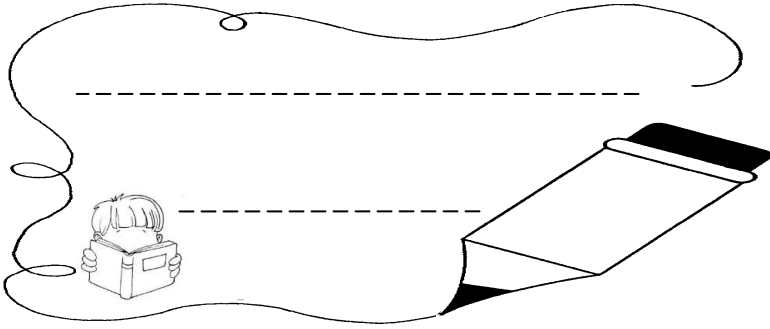
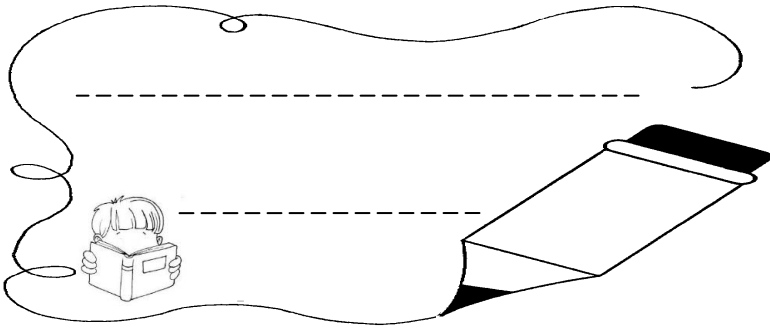
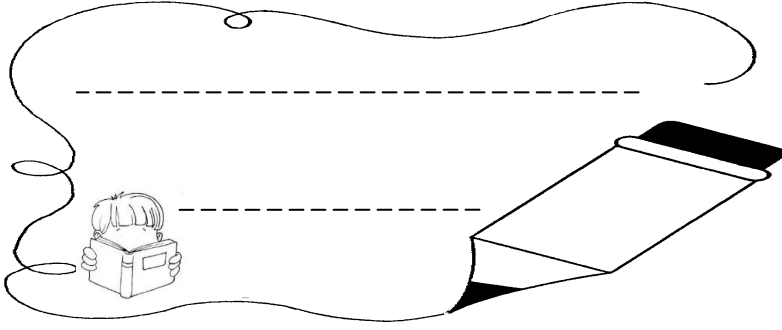

السؤال الرابع / أكمل التركيبات : / (2.5 درجة)

Complete the constructions:



She went

..... = ذَهَبَ + تْ / 1



You(singular male) sat

..... = جَلَسَ + تَ / 2



She took

..... = أَخَذَ + تَ / 3



She wrote

..... = كَتَبَ + تَ / 4



I plucked

..... = قَطَفَ + تَ / 5

السؤال الخامس / اكتب معاني الكلمات الآتية بالعربية: (2.5 درجة)

Write the following words meaning in Arabic:

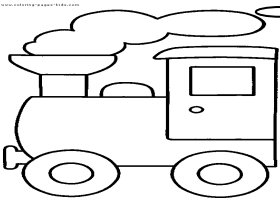

1. The pond

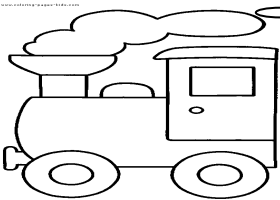

2. The meat

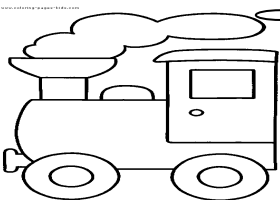

3. The butcher

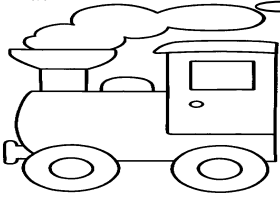

4. The Food

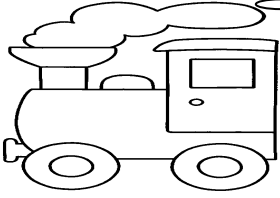

5. people

السؤال السادس / أكتب المبتدأ و الخبر كما هو موضح في المثال: (2 درجة)

Write the subjects and predicates as shown in the example:

خبر	مبتدأ	
مشغول في العمل	الولد الكبير	1/الولد الكبير مشغول في العمل.
		2/الولد الصغير مشغول في اللعب.
		3/هذا دكان الفواكه.
		4/هذان رجلان صالحان.
		5/ أولئك مدرسون مخلصون.

(3 درجة) /

السؤال السابع / إجعل المطابقة بين ما يلي:

Match the following:

The teacher is before the blackboard. ✓

1 / ما اسم والدك ؟

What is your father's name? ✓

2 / أين المُدرس؟

Where is the teacher? ✓

3 / أ أنت صاحب دكان ؟

Are you owner of a shop? ✓

4 / اسم والدي عُمان.

My father's name is Noman. ✓

5 / نعم ، أنا صاحب دكان.

Yes, I am owner of a shop. ✓

6 / المُدرسُ أمام السبورة.

